

IF IN DOUBT - ASK

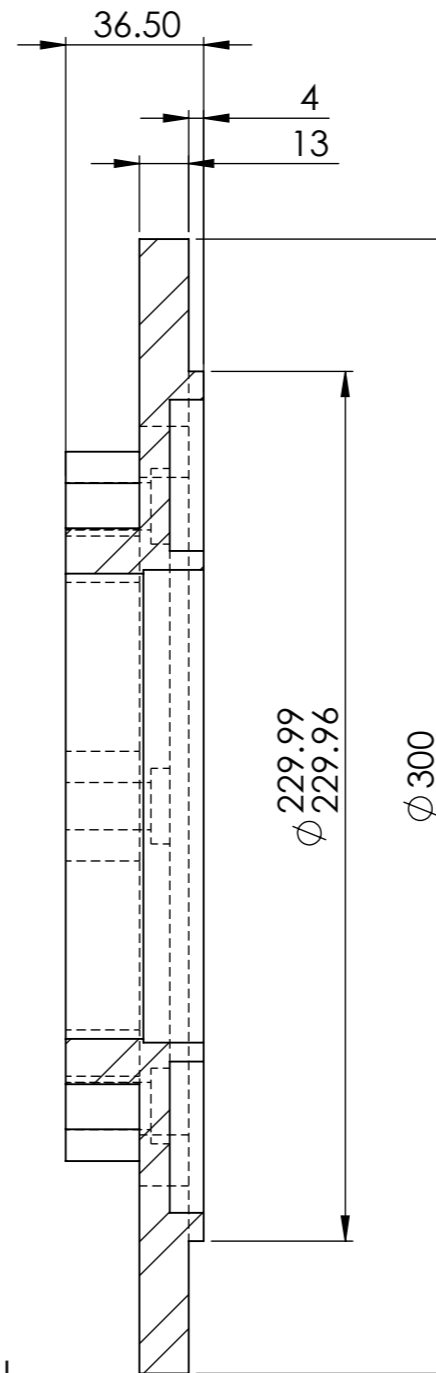

SECTION A-A

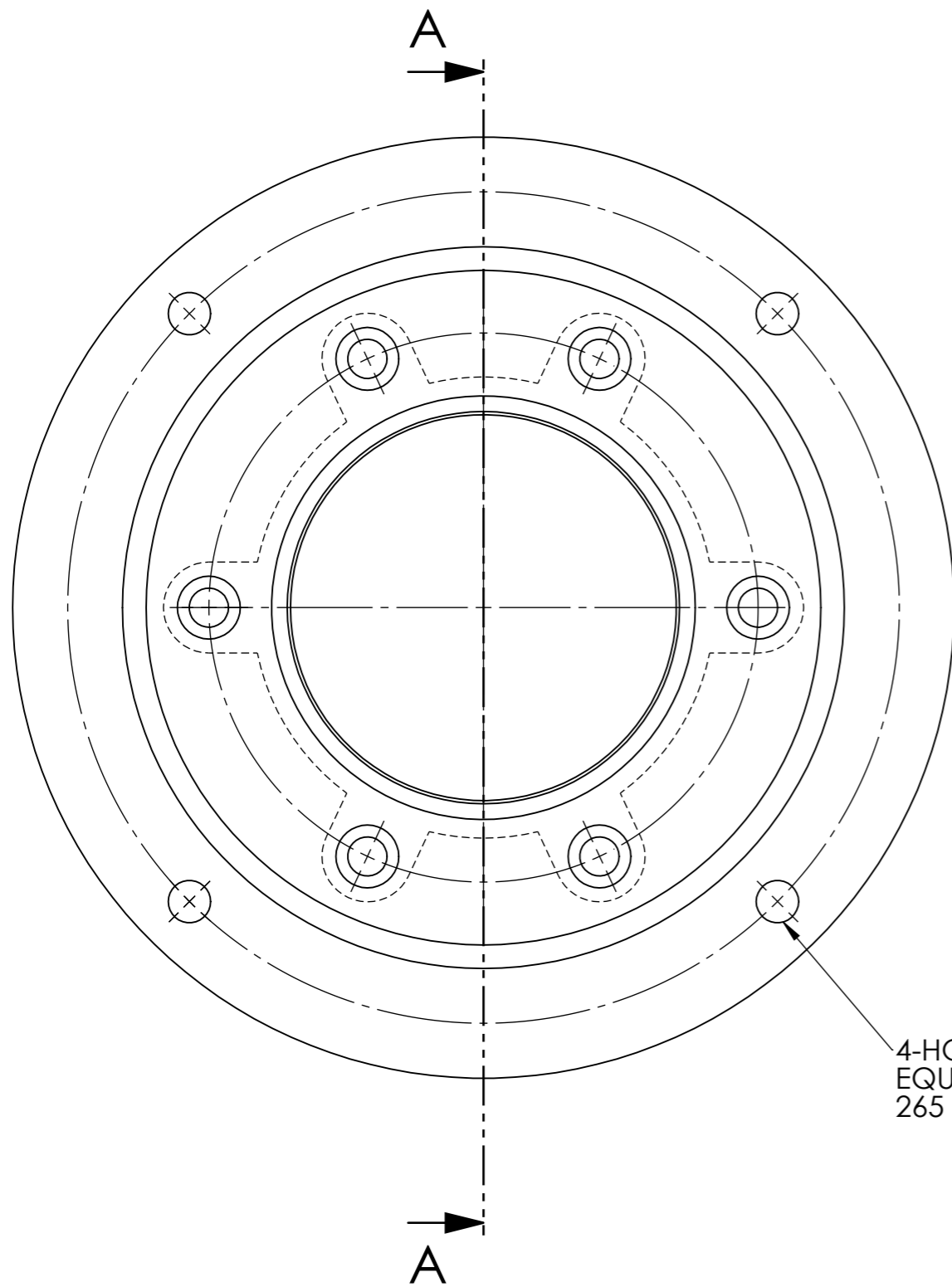
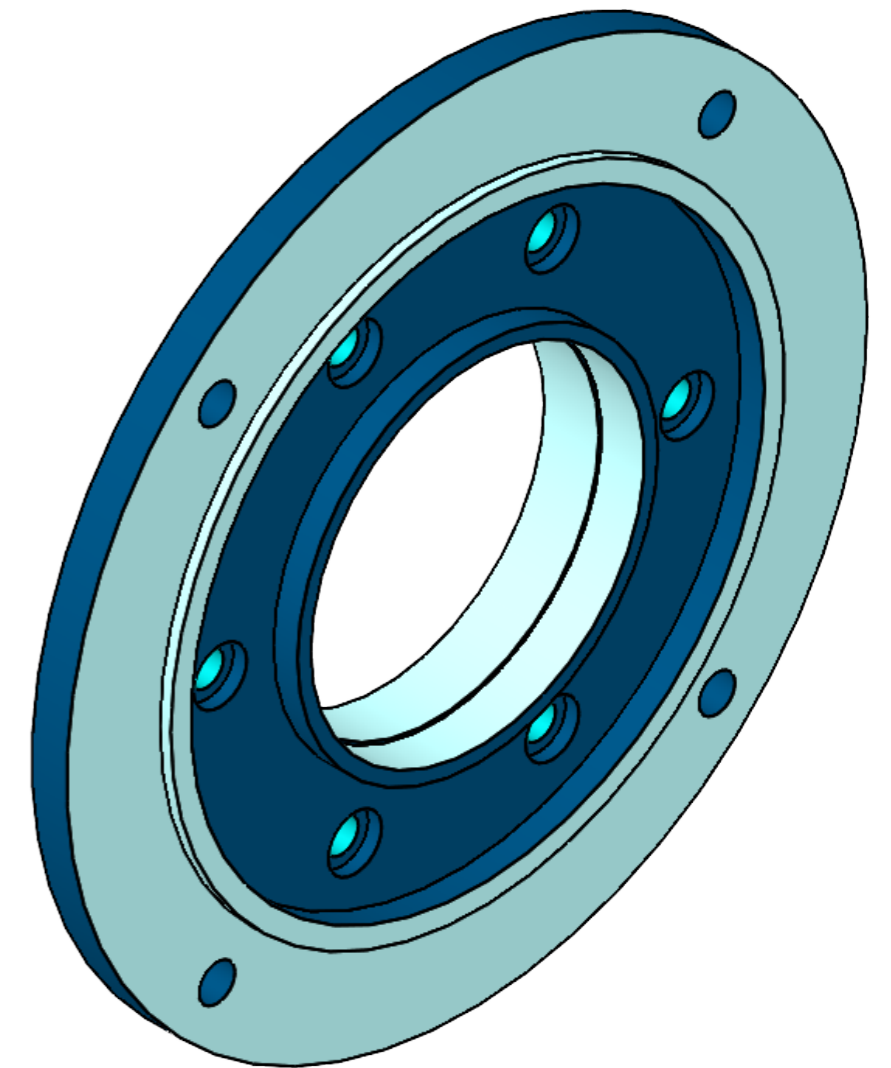

ELECTRIC MOTORS & GEARBOXES LTD

ASHMORE LAKE INDUSTRIAL ESTATE, WILLENHALL, WEST MIDLANDS, WV12 4LH
PHONE 01902 601403, FAX 01902 601408.
E MAIL sales @emag-ltd.co.uk

THIS DRAWING IN DESIGN & DETAIL IS THE PROPERTY OF EMAG LTD AND IS INTENDED SOLELY FOR THE USE OF THE PERSON OR COMPANY TO WHOM IT IS ISSUED. IN NO EVENT SHALL IT BE COPIED OR LOANED WITHOUT THE EXPRESS PERMISSION OF EMAG LTD

© ELECTRIC MOTORS & GEARBOXES LTD		FIRST ANGLE PROJECTION	
TITLE HL50_FL_300_20102357		CLIENT	
DRAWN R SPENCER	SCALE 1:2 (A3)	DRG No HL50 FL D300	
DATE			